



# Reliable automation of smoke and fire protection

Catalogue for drives, control units and accessories from  
**Becker.**



**BECKER**  
Together it's easier.



At Becker, we have a tradition of top quality. At the end of the production process, each drive undergoes a full inspection, where its performance characteristics are meticulously checked.

## Together it's easier is the philosophy we live by.



**Frank Haubach**  
General Manager

Dear customer,

We are both operating in an exciting market with an important task. Sad statistics confirm that 80% of fire-related deaths are caused by smoke. Whereas automated drives and control units were previously a luxury for a wide range of applications, we now use sophisticated, tried-and-tested technology as standard in preventative smoke and fire protection in commercial and public buildings. We are motivated by our commitment to working with you to meet technological, normative and country-specific requirements. Both then and now, we at Becker have one key aim: we want to be by your side as a reliable partner – we are happy to advise you in the complex design and provision of high-quality drive technologies. Let's work together to make smoke and fire protection even safer!

We are delighted to be presenting this catalogue highlighting the application possibilities of our drives and control units for smoke and fire protection applications. If you have any questions or comments when planning your projects, please don't hesitate to give us a call.

Yours

*Frank Haubach*

Frank Haubach  
General Manager

PS: Do you know about our Becker Academy? It's where we offer training courses and seminars on everything to do with our drives and control units. Further information on this can be found at [www.becker-antriebe.en](http://www.becker-antriebe.en).

# At home all over the world.

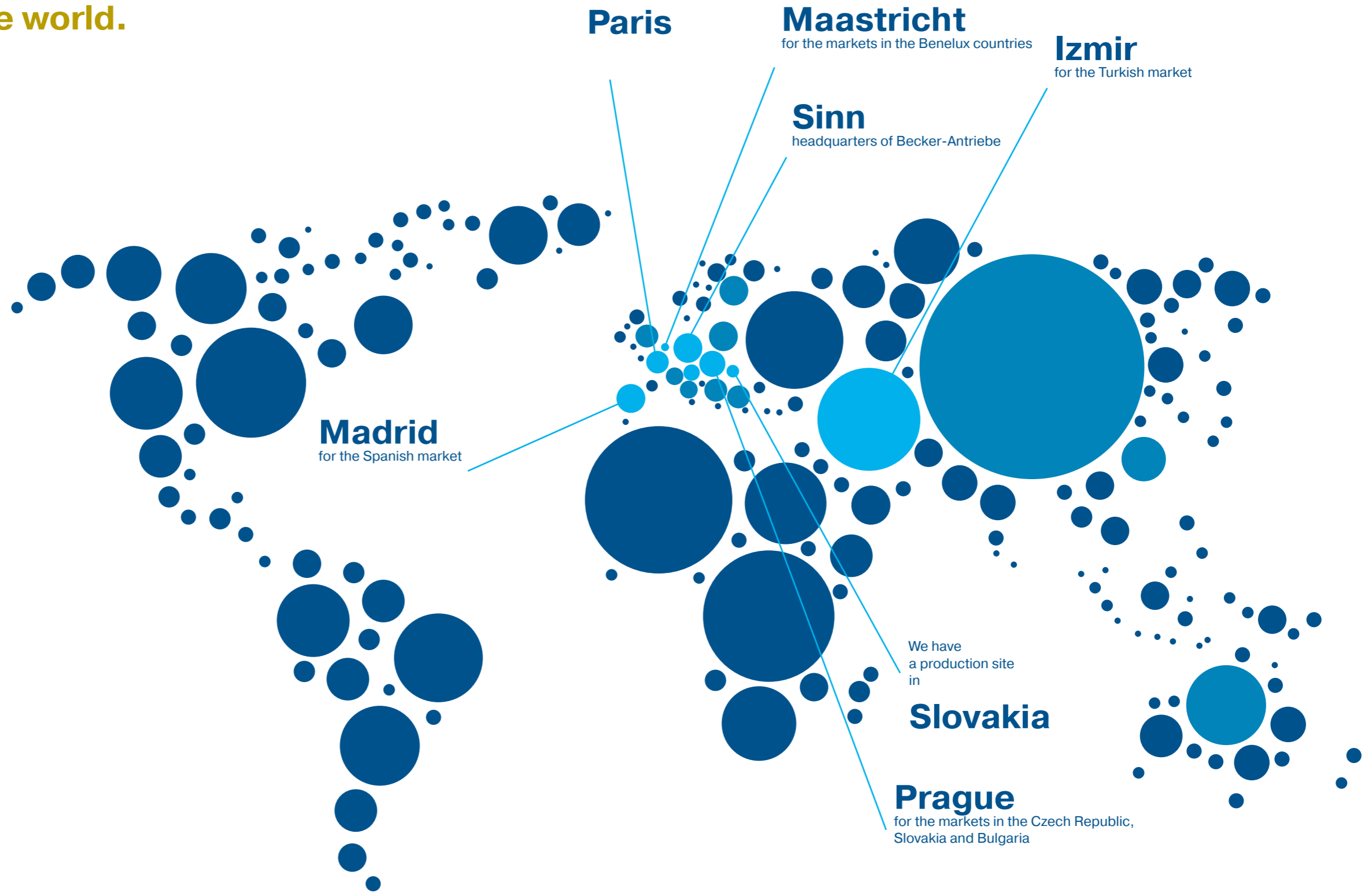

Over 250 employees  
in Germany and  
another 100 abroad

help people throughout the world to make  
their lives safer and more convenient.

We are personally available for you, as  
well as our partners in the specialist trade,  
at many locations throughout Europe. In  
addition, we work together with represen-  
tatives and permanent partners throughout  
the world.

● In addition to the global subsidiary companies shown above, you will find our other  
partners and representatives at [www.becker-antriebe.en](http://www.becker-antriebe.en)

# Your safety is what drives us.

## Competent solutions for demanding requirements.

### The best thing about our ideas is their flexibility

Developed and produced in Germany, our drive solutions can be integrated into almost any application with flexibility.

The wide range of applications and sectors in which our drives are already being successfully used proves just how versatile they are in terms of their technical usage possibilities: whether in pool covers, in agriculture, the caravanning sector or the shipping industry. Becker drives can be found wherever the associated technologies require power that is reliable, safe and above all compatible with the relevant components – and this also applies to the automation of smoke and fire curtains.

### Quality to rely on



Today we operate globally, but as a family-owned business, we have kept our roots in the town of Sinn, in Hessen, where the company was first established.

And we continue to manufacture our products in Germany. What's more, every drive is subjected to comprehensive testing on our specially developed test benches, ensuring quality that you and your customers can rely on - and we've been doing this for 100 years.

### Our drives, taken one step further for your ideas



In line with our "Together it's easier" claim, we can provide you with a drive assembly kit system that is

primarily intended for applications for which no standard drive solutions exist.

After all, our technology is tried and tested, giving you the security of an established, technically proven solution.

### Simply efficient



We regard it as our key drive that we are certified to DIN EN ISO 9001 and that we strive constantly to become even better for our customers and partners. At the

same time, we take our environmental responsibility very seriously, so energy efficiency is high on our list of priorities. For solutions that are guaranteed to succeed on a permanent basis.



### Reliable protection in an emergency

Our drives for the smoke and fire protection area feature technology at the very highest level. To guarantee maximum safety, compliance with standards and classifications is as important as it is necessary.



#### Combining technologies:

The self-closing properties combined with our tried-and-tested closing speed regulators are what make our fail-safe drives unique.



#### Standards:

Our tubular drives meet the requirements of the relevant standards for your system, such as hEN 16034 or EN 12101-1.



#### Locking device:

The locking device that is integrated into most of our drives is DIBt-approved and externally monitored – together, we are making fire protection even safer.



#### C2 classification:

Our drives have a minimum service life of 10,000 cycles, and therefore form the basis for your C2 classification.

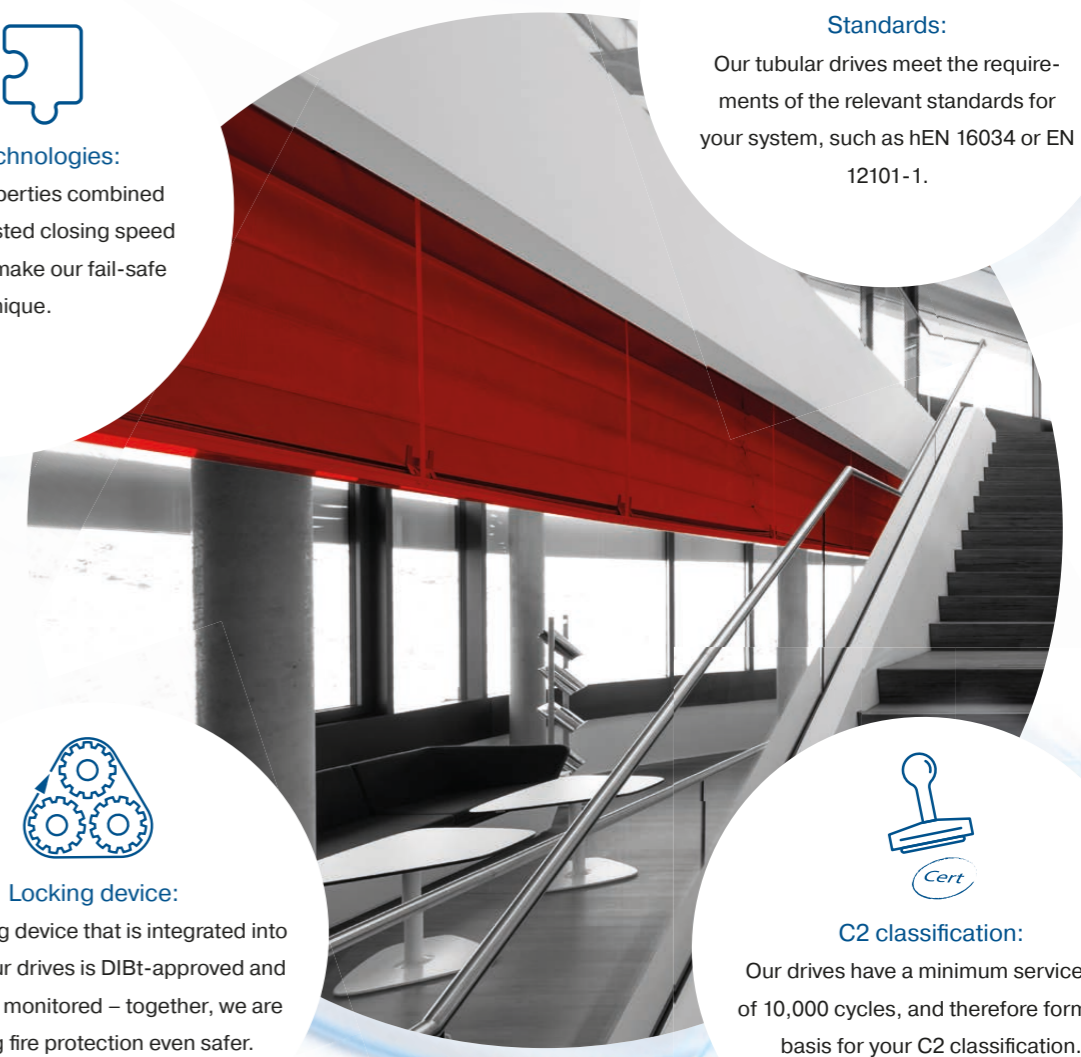



# Content

<b>General technical information .....</b>	<b>10</b>
Torque .....	12
Unrolling speed .....	13
System versions and classification .....	14
Load table .....	16
Smoke curtain .....	16
Smoke and fire protection door .....	18
Fire protection door .....	20
<b>Drives .....</b>	<b>22</b>
Type matrix .....	22
M 9A .....	25
M FKB 9A .....	27
M FKB 9A ALU .....	29
M FKB 7A .....	31
G 7A .....	33
G 12A .....	35
G FKB 12A .....	37
G 24V DC FKB .....	39
G 5A OE .....	41
G 5A OE MH .....	43
<b>Control units .....</b>	<b>44</b>
Type matrix .....	44
Control unit GSA 24V ASB .....	46
<b>Mechanical accessoires .....</b>	<b>48</b>
Wall brackets .....	50
Wall brackets .....	51
Connecting pieces .....	52
Drive adapters and rings .....	54
Drive adapters and rings .....	55
Drive adapters and rings .....	56
<b>ANNEX .....</b>	<b>58</b>
Extended Applications .....	60
General .....	
Conditions of sale .....	61
Becker Academy .....	62

# General technical information

## Determining the drive torque

To determine the required drive torque, various parameters need to be known. The following load tables, which are aimed at the particular applications, are intended as an initial overview and a rough starting point.

We will gladly support you in calculating the drive torque requirements for your smoke and fire protection system.

## Determining the unrolling speed

Depending on the particular area of application, there are normative and country-specific provisions regarding the unrolling speed. European standard hEN16034 requires compliance with the average unrolling speed of 0.15 m/s. The closing speed regulators with various output speeds that are integrated into Becker drives meet this requirement. Depending on the system being used, there are various output speeds as shown in the following table.



## INFO

Permissible cable lengths and cross-sections must be observed. With DC drives, a regenerative effect may occur during the breakaway part of the unrolling process. This must be taken into account when selecting the control unit.

## Drives with 230V AC rated voltage

Example of drive torque - speed - current consumption relationship:

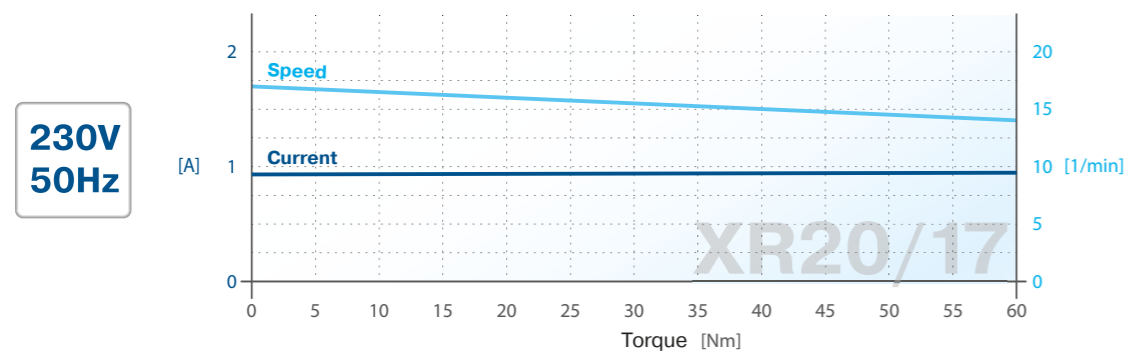

## Drives with 24V DC rated voltage

Example of drive torque - speed - current consumption relationship:

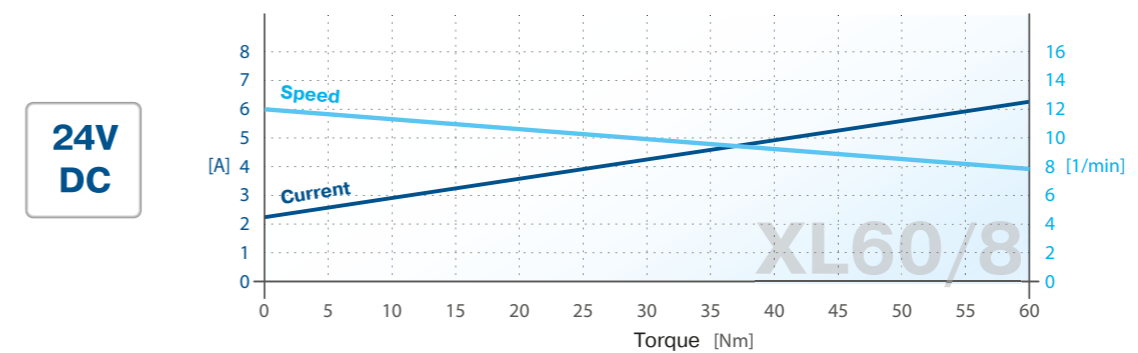

## Nomenclature example:

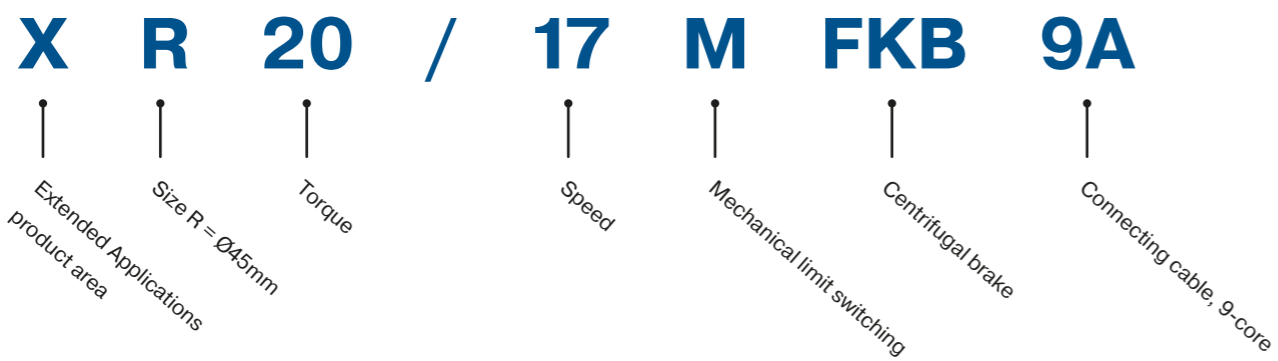

## Nomenclature example:

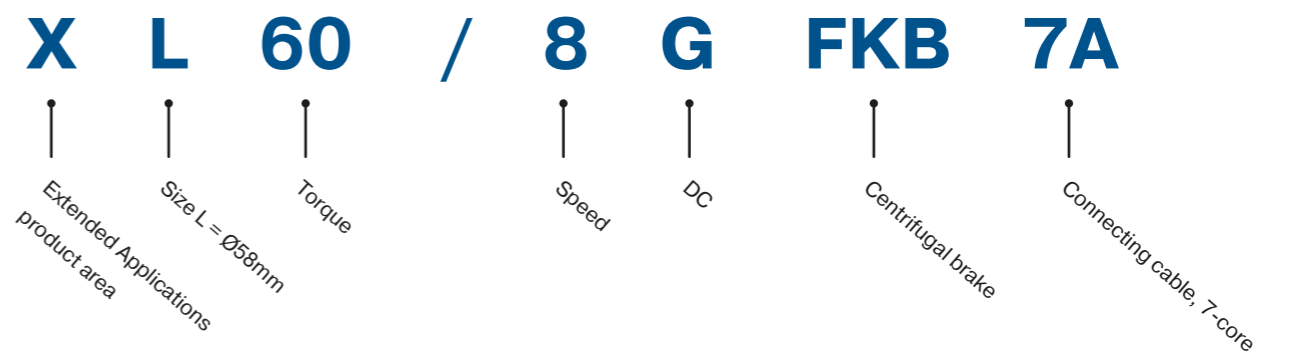

# Torque

The torque progression depends on fundamental system properties such as

- Drop length
- System width
- Specific fabric weight
- Winding shaft diameter
- Bottom bar weight
- Friction loss
- Environmental influences such as the temperature

During the winding process, the fabric is gradually wound onto the barrel. The roll diameter therefore continually increases, which has a direct impact on the lever arm and therefore the torque. At the same time, the weight of the fabric decreases, which leads to a reduction in necessary torque. The following examples illustrate the importance of the correct setup.

— = Torque progression  
 Y axis = Drive torque (Nm)  
 X axis = Drop length



## Example: EI fabric solution

- High drop length
- Large winding shaft diameter
- High fabric thickness

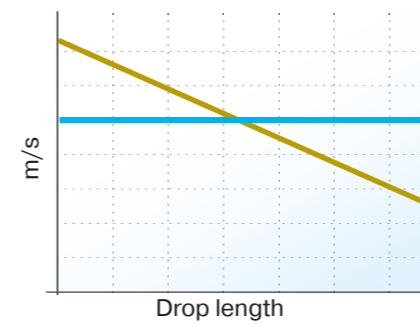
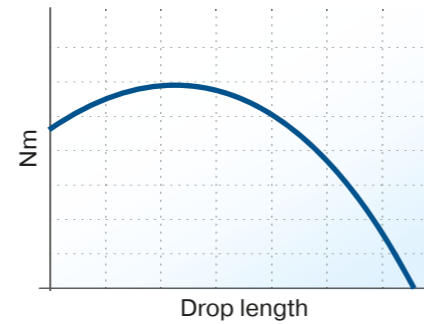

## Example: EW fabric solution

- Low drop length
- Small winding shaft diameter
- Low fabric thickness

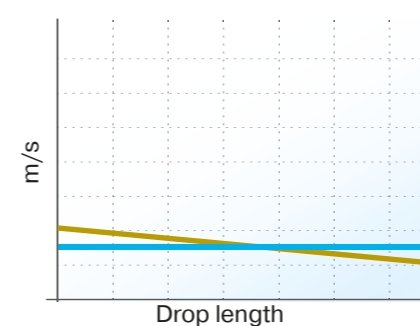
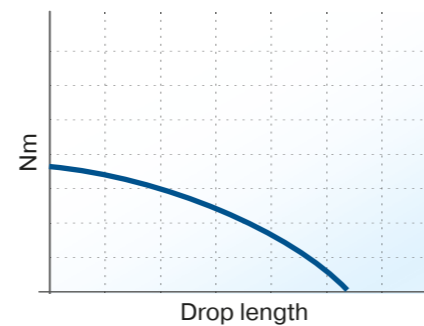

## Example: DH fabric solution

- High drop length
- Large winding shaft diameter
- Low fabric thickness

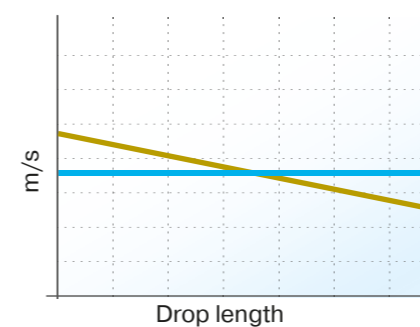
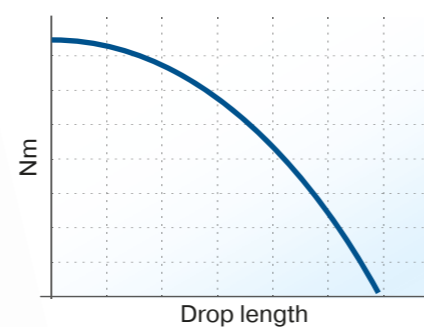

# Unrolling speed

The unrolling speed also depends on fundamental system properties such as

- Drop length
- System width
- Specific fabric weight
- Winding shaft diameter
- Bottom bar weight
- Friction loss
- Environmental influences such as the temperature

The unrolling procedure starts from the upper limit position when the fabric is wound up. The winding shaft diameter, and therefore also the circumferential speed, both reduce as the unrolling process continues. The unrolling speed is therefore significantly higher at the top section than at the bottom section. Due to the dynamics, the average speed is evaluated, and is in some cases a normative requirement.



The following examples illustrate the major importance of the correct setup.

— = Average speed  
 — = Absolute speed  
 Y axis = Unrolling speed (m/s)  
 X axis = Drop length

## System versions and classification

There are different classifications for smoke and fire protection systems. Depending on the requirements regarding smoke-tightness, stability, heat-resistance and other properties, the system components vary in terms of the thickness of the fabric or the diameter of the barrel, for example. The setup of the necessary drive torque must therefore be considered on a case-by-case basis.

As a result of the system parameters and the selection of the specific drive, different rotational unrolling speeds also occur, which have an impact on the unrolling speed depending on the individual system parameters.

Using three different examples, the individual values are summarised in a load table on the following pages, based on system parameters adopted by us.

- Smoke curtain (e.g. DH90-classified)
- Smoke and fire protection curtain (e.g. EW60-classified)
- Smoke and fire protection curtain (e.g. EI120-classified)

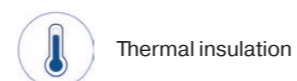
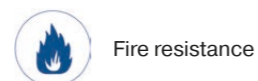
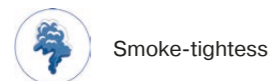
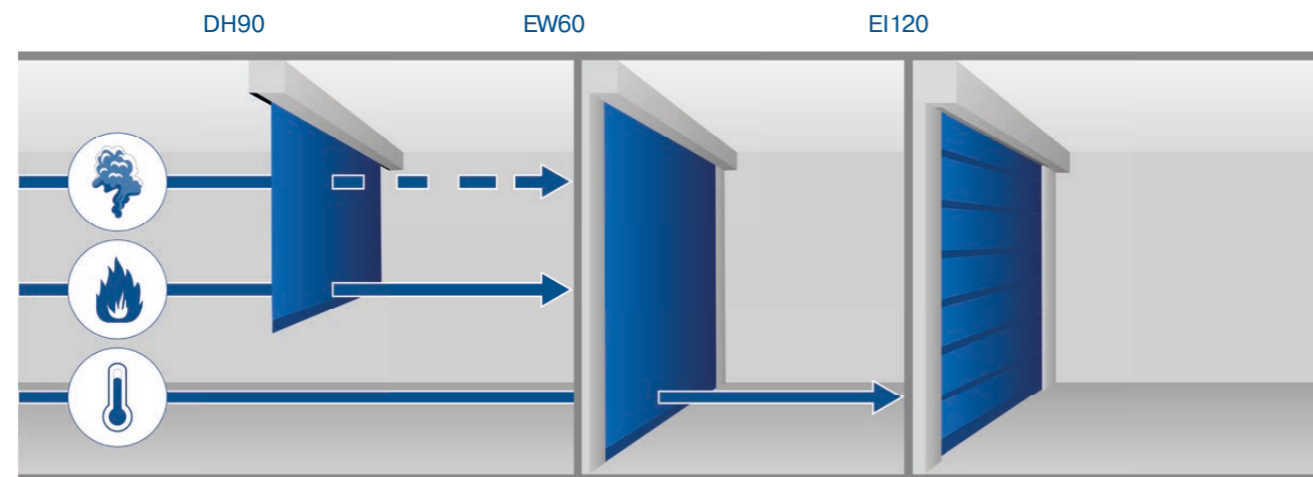



# Load table

## Smoke curtain

Calculation basis for smoke curtain:

- Profile/fabric thickness: 0.9 mm (A)
- Bottom bar weight: 3 kg/m (B)
- Specific fabric weight: 0.5 kg/m<sup>2</sup> (C)
- Winding shaft diameter: 78 mm (D)
- Friction: 15%

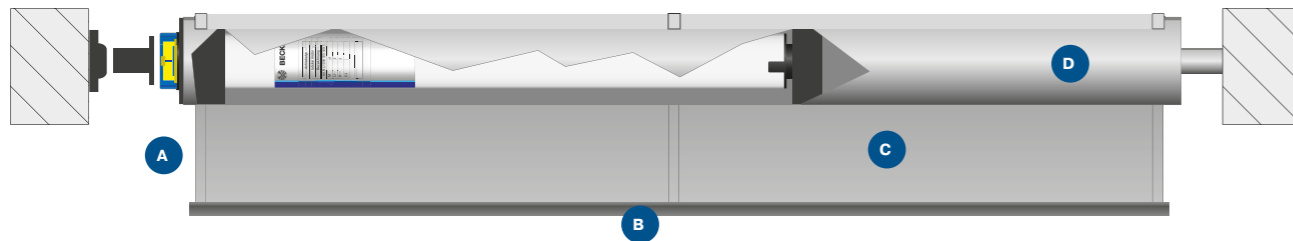

### INFO

The available rotational output speeds can be found in the relevant technical data for the drive:



Nm	Fabric width [m]																				m/s	Closing speed regulator [U/min]			
	1	2	3	4	5	6	7	8	9	10	11	12	13	14	15	16	17	18	19	20		28	20	16	8
1	2	3	5	6	8	9	11	12	14	16	17	19	20	22	23	25	27	28	30	31	0,13	0,09	0,08	0,04	
2	2	4	5	7	9	11	12	14	16	18	20	21	23	25	27	28	30	32	34	36	0,13	0,10	0,08	0,05	
3	2	4	6	8	10	12	14	16	18	20	22	24	26	28	30	32	34	36	38	40	0,14	0,10	0,08	0,05	
4	2	4	7	9	11	13	16	18	20	22	24	27	29	31	33	36	38	40	42	44	0,14	0,10	0,09	0,05	
5	2	5	7	10	12	15	17	20	22	24	27	29	32	34	37	39	42	44	46	49	0,15	0,11	0,09	0,05	
6	3	5	8	11	13	16	19	21	24	27	29	32	35	37	40	43	45	48	51	53	0,15	0,11	0,09	0,05	
7	3	6	9	12	14	17	20	23	26	29	32	35	38	40	43	46	49	52	55	58	0,15	0,11	0,09	0,05	
8	3	6	9	12	16	19	22	25	28	31	34	37	40	43	47	50	53	56	59	62	0,16	0,12	0,10	0,05	
9	3	7	10	13	17	20	23	27	30	33	37	40	43	47	50	53	57	60	63	66	0,16	0,12	0,10	0,05	
10	4	7	11	14	18	21	25	28	32	35	39	43	46	50	53	57	60	64	67	71	0,17	0,12	0,10	0,06	
11	4	8	11	15	19	23	26	30	34	38	41	45	49	53	57	60	64	68	72	75	0,17	0,12	0,10	0,06	
12	4	8	12	16	20	24	28	32	36	40	44	48	52	56	60	64	68	72	76	80	0,17	0,13	0,10	0,06	
13	4	9	13	17	21	25	30	34	38	42	46	51	55	59	63	67	72	76	80	84	0,18	0,13	0,11	0,06	
14	5	9	13	18	22	27	31	35	40	44	49	53	58	62	66	71	75	80	84	89	0,18	0,13	0,11	0,06	
15	5	9	14	19	23	28	33	37	42	47	51	56	60	65	70	74	79	84	88	93	0,19	0,13	0,11	0,06	
16	5	10	15	20	24	29	34	39	44	49	54	58	63	68	73	78	83	88	92	97	0,19	0,13	0,11	0,06	
17	5	10	15	20	26	31	36	41	46	51	56	61	66	71	76	81	87	92	97	102	0,19	0,14	0,11	0,06	
18	5	11	16	21	27	32	37	43	48	53	58	64	69	74	80	85	90	96	101	106	0,20	0,14	0,11	0,06	
19	6	11	17	22	28	33	39	44	50	55	61	66	72	77	83	89	94	100	105	111	0,20	0,14	0,12	0,06	
20	6	12	17	23	29	35	40	46	52	58	63	69	75	81	86	92	98	104	109	115	0,21	0,14	0,12	0,07	

### Example

The dimensions of a smoke curtain are 5 x 10 m (W x H) and the average closing speed of 0.15 m/s must not be exceeded.

From the table, we can derive that:

The drive torque is: 18 Nm  
 When selecting a closing speed regulator that guarantees a rotational speed of 20 rpm, the average speed is 0.12 m/s, and is therefore below the maximum permissible speed.

This means that a **XR20/17M FKB20 9A** could be used, for example.

Exclusion of liability:  
 All specifications are calculated values based on physical variables and are dependent on the particular system as well as external factors. This load table has been created with the utmost care. Becker-Antriebe GmbH accepts no liability for incorrect drive setups arising from the use of this load table. Becker-Antriebe GmbH reserves the right to make changes to the load table at any time and without prior notice.

# Load table

## Smoke and fire protection door

Calculation basis for smoke and fire protection door:

- Profile/fabric thickness: 2 mm (A)
- Bottom bar weight: 4 kg/m (B)
- Specific fabric weight: 1.0 kg/m<sup>2</sup> (C)
- Winding shaft diameter: 85 mm (D)
- Friction: 15%

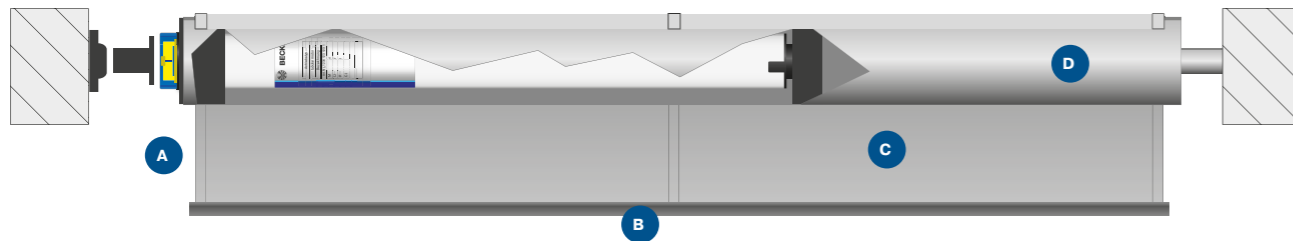

### INFO

The available rotational output speeds can be found in the relevant technical data for the drive:



Nm	Fabric width [m]																				m/s	Closing speed regulator [U/min]			
	1	2	3	4	5	6	7	8	9	10	11	12	13	14	15	16	17	18	19	20		28	20	16	8
1	2	3	7	10	12	15	18	20	23	26	28	31	33	36	39	41	44	47	49	52	0,14	0,11	0,09	0,05	
2	3	6	9	12	15	18	21	24	27	29	32	35	38	41	44	47	50	53	56	59	0,15	0,11	0,09	0,05	
3	3	9	10	14	17	20	24	27	30	33	37	40	43	46	50	53	56	59	63	66	0,16	0,12	0,10	0,05	
4	4	12	12	16	20	23	27	30	34	37	41	44	48	51	55	58	62	66	69	73	0,17	0,13	0,10	0,06	
5	4	15	13	18	22	26	30	34	37	41	45	49	53	57	60	64	68	72	76	79	0,18	0,13	0,11	0,06	
6	5	18	15	20	25	29	33	37	41	45	49	53	57	62	66	70	74	78	82	86	0,19	0,14	0,11	0,06	
7	5	21	16	22	27	31	36	40	45	49	53	58	62	67	71	76	80	84	89	93	0,19	0,14	0,11	0,07	
8	6	24	18	24	29	34	39	44	48	53	58	62	67	72	77	81	86	91	95	100	0,2	0,15	0,12	0,07	
9	6	26	19	26	32	37	42	47	52	57	62	67	72	77	82	87	92	97	102	107	0,2	0,15	0,12	0,07	
10	7	29	21	27	34	40	45	50	56	61	66	71	77	82	87	93	98	103	108	114	0,21	0,15	0,13	0,07	
11	7	32	22	29	37	42	48	54	59	65	70	76	81	87	93	98	104	109	115	121	0,21	0,16	0,13	0,07	
12	8	35	24	31	39	45	51	57	63	69	75	80	86	92	98	104	110	116	122	127	0,22	0,16	0,13	0,07	
13	8	38	25	33	42	48	54	60	66	73	79	85	91	97	103	110	116	122	128	134	0,23	0,17	0,14	0,08	
14	9	41	26	35	44	51	57	64	70	76	83	89	96	102	109	115	122	128	135	141	0,23	0,17	0,14	0,08	
15	9	44	28	37	47	53	60	67	74	80	87	94	101	107	114	121	128	135	141	148	0,24	0,17	0,14	0,08	
16	10	47	29	39	49	56	63	70	77	84	91	98	106	113	120	127	134	141	148	155	0,25	0,18	0,15	0,08	
17	10	50	31	41	51	59	66	74	81	88	96	103	110	118	125	132	140	147	154	162	0,25	0,18	0,15	0,09	
18	11	53	32	43	54	62	69	77	85	92	100	107	115	123	130	138	146	153	161	169	0,26	0,19	0,16	0,09	
19	11	56	34	45	56	64	72	80	88	96	104	112	120	128	136	144	152	160	168	176	0,27	0,19	0,16	0,09	
20	12	59	35	47	59	67	75	84	92	100	108	116	125	133	141	149	158	166	174	182	0,27	0,2	0,16	0,09	

### Example

The dimensions of a smoke and fire protection door are 10 x 3m (W x H) and the average closing speed of 0.15 m/s must not be exceeded.

From the table, we can derive that:

The drive torque is: 33 Nm  
 When selecting a closing speed regulator that guarantees a rotational speed of 16 rpm, the average speed is 0.10 m/s, and is therefore below the maximum permissible speed.

This means that a **XL60/11M FKB16 9A** could be used, for example.

Attention: Values below the red line exceed Becker's maximum permissible total weight of 150 kg drawbar load on the drive head.  
 Exclusion of liability:  
 All specifications are calculated values based on physical variables and are dependent on the particular system as well as external factors. This load table has been created with the utmost care. Becker-Antriebe GmbH accepts no liability for incorrect drive setups arising from the use of this load table. Becker-Antriebe GmbH reserves the right to make changes to the load table at any time and without prior notice.

# Load table

## Fire protection door

Calculation basis for fire protection door:

- Profile/fabric thickness: 18 mm (A)
- Bottom bar weight: 5 kg/m (B)
- Specific fabric weight: 7 kg/m<sup>2</sup> (C)
- Winding shaft diameter: 133 mm (D)
- Friction: 15%

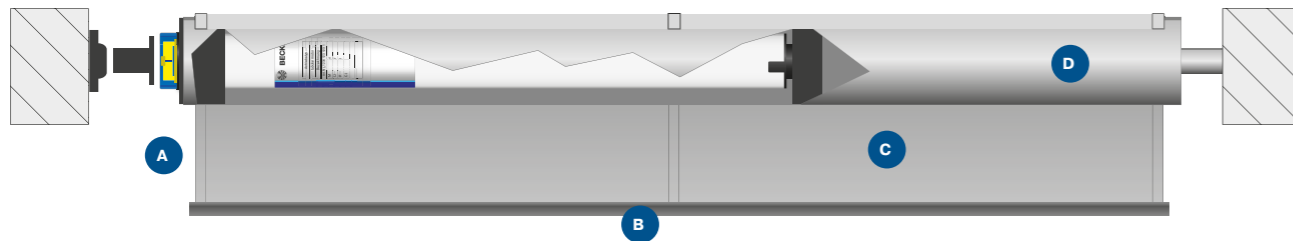

### INFO

The available rotational output speeds can be found in the relevant technical data for the drive:



Nm	Fabric width [m]										m/s	Closing speed regulator [U/min]			
	1	2	3	4	5	6	7	8	9	10		28	20	16	8
1	10	20	31	41	51	61	72	82	92	102		0,28	0,21	0,17	0,09
1,5	13	26	40	53	66	79	92	106	119	132		0,3	0,22	0,17	0,10
2,0	16	32	49	65	81	97	113	130	146	162		0,31	0,23	0,18	0,10
2,5	20	40	60	80	100	121	141	161	181	201		0,33	0,24	0,19	0,11
3,0	24	48	72	96	120	143	167	191	215	239		0,34	0,25	0,20	0,11
3,5	28	55	83	111	139	166	194	222	249	277		0,35	0,26	0,21	0,12
4,0	31	63	94	126	157	189	220	252	283	315		0,36	0,27	0,22	0,12
4,5	36	71	107	143	179	214	250	286	321	357		0,38	0,28	0,23	0,13
5,0	40	81	121	161	201	242	282	322	362	403		0,39	0,29	0,24	0,13

### Example

The dimensions of a fire protection door are 5 x 2.5 m (W x H) and the average closing speed of 0.15 m/s must not be exceeded.

From the table, we can derive that:

The drive torque is 100 Nm. When selecting a closing speed regulator that guarantees a rotational speed of 8 rpm, the average speed is 0.11 m/s, and is therefore below the maximum permissible speed.

This means that a **XL200/3M FKB 9A** could be used, for example.

Exclusion of liability:  
All specifications are calculated values based on physical variables and are dependent on the particular system as well as external factors. This load table has been created with the utmost care. Becker-Antriebe GmbH accepts no liability for incorrect drive setups arising from the use of this load table. Becker-Antriebe GmbH reserves the right to make changes to the load table at any time and without prior notice.

# Drives

## Type matrix

	M 9A	M FKB(8...28) 9A	M FKB 9A MH	M FKB(8...28) 7A	G 7A	G 12A	G FKB 12A	G 24V DC FKB	G 5A OE	G 5A OE MH
<b>Power supply</b>	230 V / 50 Hz	230 V / 50 Hz	230 V / 50 Hz	230 V / 50 Hz	24 V / DC	24 V / DC	24 V / DC	24 V / DC	24 V / DC	24 V / DC
<b>Limit switching</b>	Mech	Mech	Mech	Mech	Mech	Mech	Mech	none	none	none
<b>Connecting cable for conductors</b>	9	9	9	7	7	12	12	5	5	5
<b>Type of limit switch*</b>	NC	NC	NC	NC	NC	NO / NC	NO / NC	none	none	none
<b>Fail-safe function</b>	yes	yes	yes	yes	yes	yes	yes	yes	yes	yes
<b>Integrated centrifugal brake</b>	no	yes	yes	yes	no	no	yes	yes	no	no
<b>Integrated interval brake</b>	no	no	no	no	yes	yes	no	no	yes	yes
<b>Metal motor head**</b>	no	no	yes	no	no	no	no	no	no	yes
<b>Class of protection</b>	IP44	IP44	IP44	IP44	IP44	IP44	IP44	IP44	IP44	IP44

\* Guided out limit switches mean that the control unit can detect when the limit position has been reached. Available either as an NC contact or a changeover contact.

\*\* Depending on country-specific specifications, a plastic motor head is not permitted. Drives with a metal motor head are intended for use in this case.

# Chapter Content

<b>Drives</b> .....	<b>22</b>
Type matrix .....	22
M 9A .....	25
M FKB 9A .....	27
M FKB 9A ALU .....	29
M FKB 7A .....	31
G 7A .....	33
G 12A .....	35
G FKB 12A .....	37
G 24V DC FKB .....	39
G 5A OE .....	41
G 5A OE MH .....	43



# drive with mechanical limit switching

Suitable for use for:

- Smoke curtain
- Smoke protection barrier
- Fire protection barrier

Item number

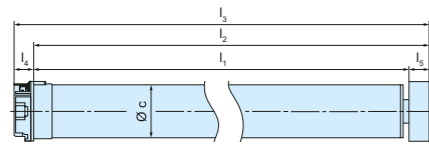

2010 091 003 0

Designation

XR12/17M 9A

Smallest shaft inner tube diameter	47 mm
Torque	12 Nm
Speed (load)	14 U/min
Speed (idling)	17 U/min
Rated voltage	230 V
Mains frequency	50 Hz
Power consumption	110 W
Rated current	0,5 A
IP degree of protection	44
Operating mode	S2 4 min
Cable length	2,5 m
Dimension L1	545,0 mm
Dimension L2	585,0 mm
Dimension L3	602,0 mm
Dimension L4	17,0 mm
Dimension L5	40,0 mm
Dimension Ø c	45 mm

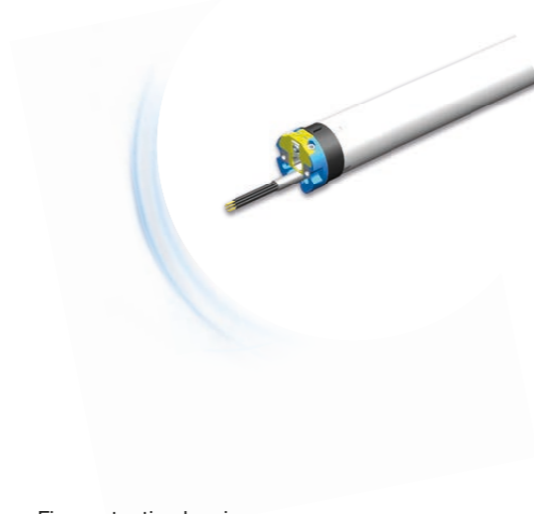

## Wiring

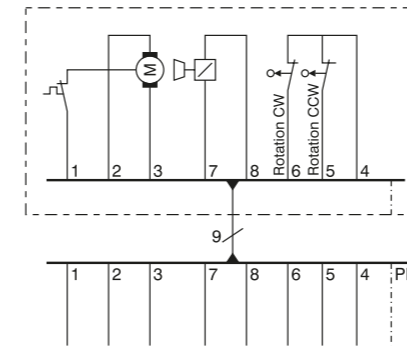

## Advantages

### Application



Made in Germany - for maximum reliability and durability



Fail-safe technology - drive enables usage in a de-energised state

### Planning



Mechanical limit switching



Limit switch guided out - one normally closed contact (NC) each for right-handed and left-handed rotation



9-wire connecting cable



Integrated locking device - the approved 24V DC magnetic brake holds the drive in position in a powered state

### Installation



Limit position adjustment - automatic detection when fixed point end-positions at top/bottom are present



# Drive with mechanical limit switching

Suitable for use for:

- Smoke curtain
- Smoke protection barrier
- Fire protection barrier

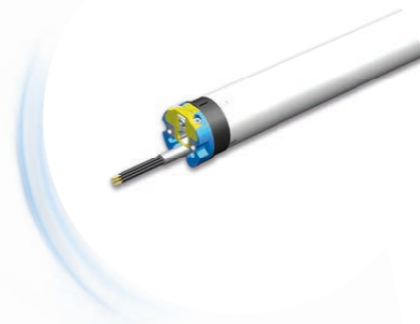

## Wiring

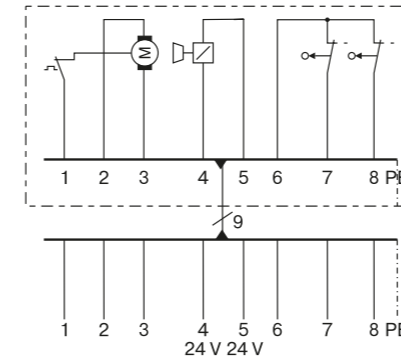

Item number

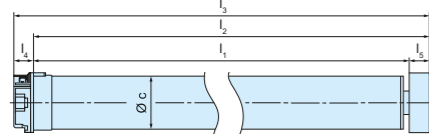

Designation

	2020 091 104 0	2020 091 105 0	2040 091 103 0	2060 091 102 0	2060 091 111 0	2060 091 114 0	2080 091 104 0	2080 091 109 0	2080 091 114 0	2120 091 112 0	2120 091 124 0	2120 091 132 0	2200 091 002 0
	XR20/17M FKB20 9A	XR20/17M FKB20 9A	XL40/17M FKB 9A	XL60/11M FKB 9A	XL60/11M FKB 9A	XL60/11M FKB 16 9A	XL80/11M FKB 9A	XL80/11M FKB 9A	XL80/11M FKB 16 9A	XL120/11M FKB 9A	XL120/11M FKB 9A	XL120/11M FKB 16 9A	XL200/3M FKB 9A
<b>Smallest shaft inner tube diameter</b>	47 mm	47 mm	60 mm	60 mm	60 mm	60 mm	60 mm	60 mm	60 mm	60 mm	60 mm	60 mm	60 mm
<b>Torque</b>	20 Nm	20 Nm	40 Nm	60 Nm	60 Nm	60 Nm	80 Nm	80 Nm	80 Nm	120 Nm	120 Nm	120 Nm	200 Nm
<b>Speed (load)</b>	14 U/min	14 U/min	14 U/min	8 U/min	8 U/min	8 U/min	8 U/min	8 U/min	8 U/min	8 U/min	8 U/min	8 U/min	2 U/min
<b>Speed (idling)</b>	17 U/min	17 U/min	17 U/min	11 U/min	11 U/min	11 U/min	11 U/min	11 U/min	11 U/min	11 U/min	11 U/min	11 U/min	3 U/min
<b>Rated voltage</b>	230 V	230 V	230 V	230 V	230 V	230 V	230 V	230 V	230 V	230 V	230 V	230 V	230 V
<b>Mains frequency</b>	50 Hz	50 Hz	50 Hz	50 Hz	50 Hz	50 Hz	50 Hz	50 Hz	50 Hz	50 Hz	50 Hz	50 Hz	50 Hz
<b>Power consumption</b>	200 W	200 W	265 W	265 W	265 W	265 W	310 W	310 W	310 W	435 W	435 W	435 W	260 W
<b>Rated current</b>	0,9 A	0,9 A	1,2 A	1,2 A	1,2 A	1,2 A	1,4 A	1,4 A	1,4 A	1,9 A	1,9 A	1,9 A	1,13 A
<b>IP degree of protection</b>	44	44	44	44	44	44	44	44	44	44	44	44	44
<b>Operating mode</b>	S2 4 min	S2 4 min	S2 4 min	S2 4 min	S2 4 min	S2 4 min	S2 4 min	S2 4 min	S2 4 min	S2 4 min	S2 4 min	S2 4 min	S2 10 min
<b>Cable length</b>	3 m	10 m	3 m	3 m	10 m	3 m	3 m	10 m	3 m	3 m	10 m	3 m	3 m
<b>Unwinding speed max.</b>	20 U/min	20 U/min	28 U/min	28 U/min	28 U/min	16 U/min	28 U/min	28 U/min	16 U/min	28 U/min	28 U/min	16 U/min	8 U/min
<b>Unwinding speed tolerance max.</b>	+4	+4	+4	+4	+4	+4	+4	+4	+4	+4	+4	+4	+4
<b>Dimension L1</b>	618,0 mm	618,0 mm	672,0 mm	672,0 mm	672,0 mm	672,0 mm	672,0 mm	672,0 mm	672,0 mm	672,0 mm	672,0 mm	672,0 mm	696,5 mm
<b>Dimension L2</b>	658,0 mm	658,0 mm	702,0 mm	702,0 mm	702,0 mm	702,0 mm	702,0 mm	702,0 mm	702,0 mm	702,0 mm	702,0 mm	702,0 mm	726,5 mm
<b>Dimension L3</b>	675,0 mm	675,0 mm	722,0 mm	722,0 mm	722,0 mm	722,0 mm	722,0 mm	722,0 mm	722,0 mm	722,0 mm	722,0 mm	722,0 mm	746,5 mm
<b>Dimension L4</b>	17,0 mm	17,0 mm	20,0 mm	20,0 mm	20,0 mm	20,0 mm	20,0 mm	20,0 mm	20,0 mm	20,0 mm	20,0 mm	20,0 mm	20,0 mm
<b>Dimension L5</b>	40,0 mm	40,0 mm	30,0 mm	30,0 mm	30,0 mm	30,0 mm	30,0 mm	30,0 mm	30,0 mm	30,0 mm	30,0 mm	30,0 mm	30,0 mm
<b>Dimension Ø c</b>	45 mm	45 mm	58 mm	58 mm	58 mm	58 mm	58 mm	58 mm	58 mm	58 mm	58 mm	58 mm	58 mm

## Advantages

### Application

- Made in Germany - for maximum reliability and durability
- Fail-safe technology - drive enables usage in a de-energised state
- Integrated closing speed regulator - limits the speed when rolling down in a de-energised state
- Lifetime-lubricated special gear with special lubricant for low roll-up torque

### Planning

- Mechanical limit switching
- Increased axial load - the drive can be statically loaded with up to 150 kg
- Limit switch guided out - one normally closed contact (NC) each for right-handed and left-handed rotation
- 9-wire connecting cable
- Integrated locking device - the approved 24V DC magnetic brake holds the drive in position in a powered state

### Installation

- Limit position adjustment - automatic detection when fixed point end-positions at top/bottom are present

# Drive with mechanical limit switching

suitable for use for:

- Smoke curtain
- Smoke protection barrier
- Fire protection barrier

Item number

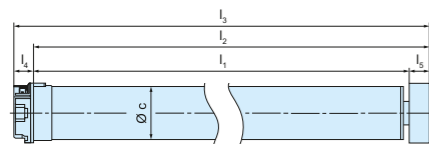

Designation

XL40/17M FKB 9A ALU 2040 091 105 0

Smallest shaft inner tube diameter	60 mm
Drive torque	40 Nm
Speed (load)	14 U/min
Speed (idling)	17 U/min
Nominal voltage	230 V
Mains frequenz	50 Hz
Power consumption	265 W
Nominal current	1,2 A
IP degree of protection	44
Operating mode	S2 4 min
Cable length	3 m
Unwinding speed max.	28 U/min
Unwinding speed tolerance max.	+4
Dimension L1	672,0 mm
Dimension L2	702,0 mm
Dimension L3	722,0 mm
Dimension L4	20,0 mm
Dimension L5	30,0 mm
Dimension Ø c	58 mm



## Wiring

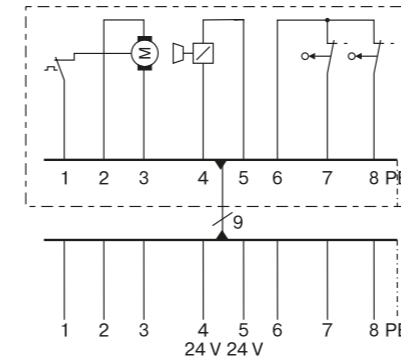

## Advantages

### Application



Made in Germany - for maximum reliability and durability



Fail-safe technology - drive enables usage in a de-energised state



Integrated closing speed regulator - limits the speed when rolling down in a de-energised state



Lifetime-lubricated special gear with special lubricant for low roll-up torque

### Planning



Mechanical limit switching



Increased axial load - the drive can be statically loaded with up to 150 kg



Limit switch guided out - one normally closed contact (NC) each for right-handed and left-handed rotation



9-wire connecting cable



Integrated locking device - the approved 24V DC magnetic brake holds the drive in position in a powered state



Metal motor head

### Installation



Limit position adjustment - automatic detection when fixed point end-positions at top/bottom are present



# Drive with mechanical limit switching

suitable for use for:

- Smoke curtain
- Smoke protection barrier
- Fire protection barrier

Item number

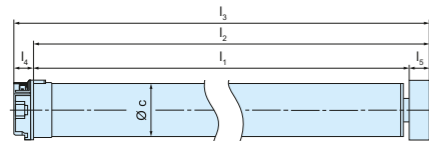

Designation

	2060 091 103 0	2060 091 115 0	2120 091 114 0	2120 091 131 0	2200 091 003 0
Designation	XL60/11M FKB 7A	XL60/11M FKB16 7A	XL120/11M FKB 7A	XL120/11M FKB16 7A	XL200/3M FKB 7A
<b>Smallest shaft inner tube diameter</b>	60 mm	60 mm	60 mm	60 mm	60 mm
<b>Drive torque</b>	60 Nm	60 Nm	120 Nm	120 Nm	200 Nm
<b>Speed (load)</b>	8 U/min	8 U/min	8 U/min	8 U/min	2 U/min
<b>Speed (idling)</b>	11 U/min	11 U/min	11 U/min	11 U/min	3 U/min
<b>Nominal voltage</b>	230 V	230 V	230 V	230 V	230 V
<b>Mains frequency</b>	50 Hz	50 Hz	50 Hz	50 Hz	50 Hz
<b>Power consumption</b>	265 W	265 W	435 W	435 W	260 W
<b>Nominal current</b>	1,2 A	1,2 A	1,9 A	1,9 A	1,13 A
<b>IP degree of protection</b>	44	44	44	44	44
<b>Operation mode</b>	S2 4 min	S2 4 min	S2 4 min	S2 4 min	S2 10 min
<b>Cable length</b>	3 m	3 m	3 m	3 m	3 m
<b>Unwinding speed max.</b>	28 U/min	16 U/min	28 U/min	16 U/min	8 U/min
<b>Unwinding speed tolerance max.</b>	+4	+4	+4	+4	+4
<b>Dimension L1</b>	672,0 mm	672,0 mm	672,0 mm	672,0 mm	696,5 mm
<b>Dimension L2</b>	702,0 mm	702,0 mm	702,0 mm	702,0 mm	726,5 mm
<b>Dimension L3</b>	722,0 mm	722,0 mm	722,0 mm	722,0 mm	746,5 mm
<b>Dimension L4</b>	20,0 mm	20,0 mm	20,0 mm	20,0 mm	20,0 mm
<b>Dimension L5</b>	30,0 mm	30,0 mm	30,0 mm	30,0 mm	30,0 mm
<b>Dimension Ø c</b>	58 mm	58 mm	58 mm	58 mm	58 mm

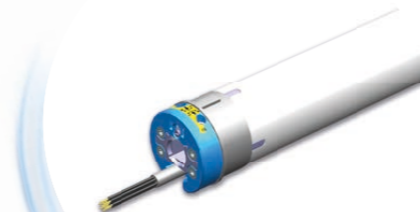

## Wiring

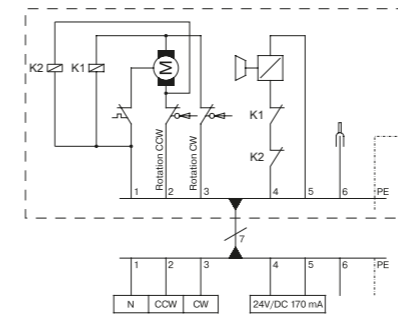

## Advantages

### Application



Made in Germany - for maximum reliability and durability



Fail-safe technology - drive enables usage in a de-energised state



Integrated closing speed regulator - limits the speed when rolling down in a de-energised state



Lifetime-lubricated special gear with special lubricant for low roll-up torque

### Planning



Mechanical limit switching



Increased axial load - the drive can be statically loaded with up to 150 kg



Limit switch guided out - one normally closed contact (NC) each for right-handed and left-handed rotation



7-wire connecting cable



Integrated locking device - the approved 24V DC magnetic brake holds the drive in position in a powered state

### Installation



Limit position adjustment - automatic detection when fixed point end-positions at top/bottom are present





# Drive with mechanical limit switching

suitable for use for:

- Smoke curtain
- Smoke protection barrier
- Fire protection barrier

Item number	2010 096 100 0	2029 096 100 0	2038 096 100 0
Designation	XL10/50G 7A	XL29/16G 7A	XL38/12G 7A
<b>Smallest shaft inner tube diameter</b>	60 mm	60 mm	60 mm
<b>Drive torque</b>	10 Nm	29 Nm	38 Nm
<b>Speed (load)</b>	52 U/min	16 U/min	12 U/min
<b>Speed (idling)</b>	85 U/min	24 U/min	19 U/min
<b>Nominal voltage</b>	24 V	24 V	24 V
<b>Mains frequency</b>	0 Hz	0 Hz	0 Hz
<b>Power consumption</b>	150 W	150 W	150 W
<b>Nominal current</b>	6,3 A	6,3 A	6,3 A
<b>IP degree of protection</b>	44	44	44
<b>Operating mode</b>	S2 8 min	S2 8 min	S2 8 min
<b>Cable length</b>	4 m	4 m	4 m
<b>Dimension L1</b>	561,5 mm	582,0 mm	582,0 mm
<b>Dimension L2</b>	591,5 mm	612,0 mm	612,0 mm
<b>Dimension L3</b>	611,5 mm	632,0 mm	632,0 mm
<b>Dimension L4</b>	20,0 mm	20,0 mm	20,0 mm
<b>Dimension L5</b>	30,0 mm	30,0 mm	30,0 mm
<b>Dimension Ø c</b>	58 mm	58 mm	58 mm



## Wiring

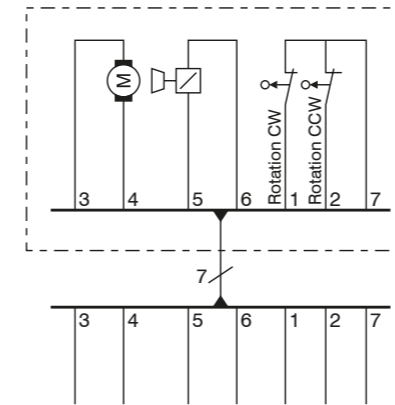

## Advantages

### Application



Made in Germany - for maximum reliability and durability



Fail-safe technology - drive enables usage in a de-energised state



Integrated closing speed regulator - limits the speed when rolling down in a de-energised state



Lifetime-lubricated special gear with special lubricant for low roll-up torque

### Planning



Mechanical limit switching



Increased axial load - the drive can be statically loaded with up to 150 kg



Limit switch guided out - one normally closed contact (NC) each for right-handed and left-handed rotation



7-wire connecting cable



Integrated locking device - the approved 24V DC magnetic brake holds the drive in position in a powered state

### Installation



Limit position adjustment - automatic detection when fixed point end-positions at top/bottom are present

# Drive with mechanical limit switching

suitable for use for:

- Smoke curtain
- Smoke protection barrier
- Fire protection barrier

Item number

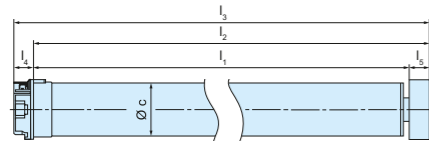

2060 096 013 0

Designation

XL60/8G 12A

Smallest shaft inner tube diameter	60 mm
Drive torque	60 Nm
Speed (load)	8 U/min
Speed (idling)	13 U/min
Nominal voltage	24 V
Mains frequency	0 Hz
Power consumption	150 W
Nominal current	6,3 A
IP degree of protection	44
Operating mode	S2 8 min
Cable length	5 m
Unwinding speed max.	16 U/min
Unwinding speed tolerance max.	+4
Dimension L1	582,0 mm
Dimension L2	612,0 mm
Dimension L3	632,0 mm
Dimension L4	20,0 mm
Dimension L5	30,0 mm
Dimension Ø c	58 mm



## Wiring

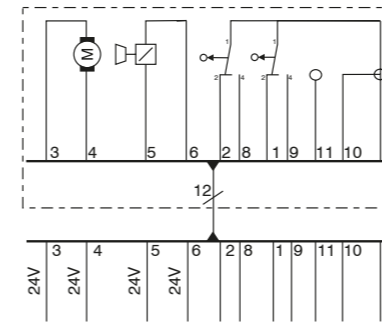

## Advantages

### Application



Made in Germany - for maximum reliability and durability



Fail-safe technology - drive enables usage in a de-energised state



Integrated closing speed regulator - limits the speed when rolling down in a de-energised state

### Planning



Mechanical limit switching



Limit switch guided out - one changeover contact (NO/NC) each for right-handed and left-handed rotation



12-wire connecting cable



Integrated locking device - the approved 24V DC magnetic brake holds the drive in position in a powered state

### Installation



Limit position adjustment - automatic detection when fixed point end-positions at top/bottom are present



# Drive with mechanical limit switching

suitable for use for:

- Smoke curtain
- Smoke protection barrier
- Fire protection barrier

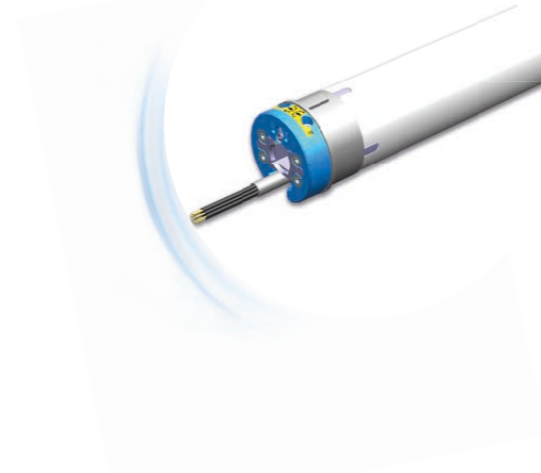

## Wiring

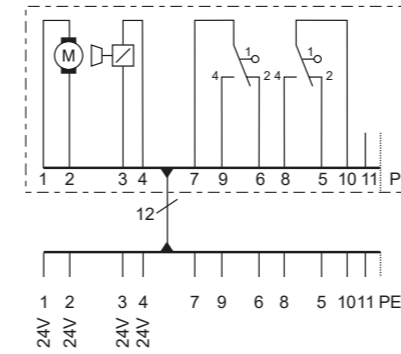

## Advantages

### Application

- Made in Germany - for maximum reliability and durability
- Fail-safe technology - drive enables usage in a de-energised state
- Integrated closing speed regulator - limits the speed when rolling down in a de-energised state
- Lifetime-lubricated special gear with special lubricant for low roll-up torque

### Planning

- Mechanical limit switching
- Limit switch guided out - one changeover contact (NO/NC) each for right-handed and left-handed rotation
- 12-wire connecting cable
- Integrated locking device - the approved 24V DC magnetic brake holds the drive in position in a powered state

### Installation

- Limit position adjustment - automatic detection when fixed point end-positions at top/bottom are present

Item number	2030 096 006 0	2120 096 103 0
Designation	XL30/14G FKB 12A	XL120/3G FKB 12A

Smallest shaft inner tube diameter	60 mm	60 mm
Drive torque	30 Nm	120 Nm
Speed (load)	14 U/min	3 U/min
Speed (idling)	24 U/min	4 U/min
nominal voltage	24 V	24 V
Mains frequency	0 Hz	0 Hz
Power consumption	150 W	125 W
Nominal current	6,3 A	6,3 A
IP degree of protection	44	44
Operating mode	S2 8 min	S2 8 min
Cable length	5 m	5 m
Unwinding speed max.	28 U/min	4 U/min
Unwinding speed tolerance max.	+4	+4
Dimension L1	582,0 mm	606,5 mm
Dimension L2	612,0 mm	636,5 mm
Dimension L3	632,0 mm	656,5 mm
Dimension L4	20,0 mm	20,0 mm
Dimension L5	30,0 mm	30,0 mm
Dimension Ø c	58 mm	58 mm

# Drive without limit switching

suitable for use for:

- Smoke curtain
- Smoke protection barrier
- Fire protection barrier



## Wiring

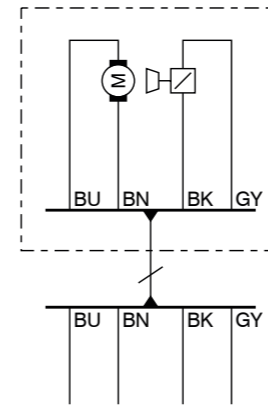

## Advantages

### Application

- Made in Germany - for maximum reliability and durability
- Fail-safe technology - drive enables usage in a de-energised state
- Integrated closing speed regulator - limits the speed when rolling down in a de-energised state
- Lifetime-lubricated special gear with special lubricant for low roll-up torque

### Planning

- WITHOUT LIMIT SWITCH** No integrated limit switching - switch-off at the limit positions is performed via an external control sensor
- Increased axial load - the drive can be statically loaded with up to 150 kg
- 5-wire connecting cable
- 24V DC magnetic brake - the approved 24V DC magnetic brake holds the drive in position in a powered state

### Installation

- Limit position detection - detection of stop limit positions only possible via current detection of an external control unit

Item number	2030 096 005 0	2060 096 021 0
Designation	XL30/14G 24V DC FKB	XL60/8G 24V DC FKB

Smallest shaft inner tube diameter	60 mm	60 mm
Drive torque	30 Nm	60 Nm
Speed (load)	14 U/min	8 U/min
Speed (idling)	24 U/min	12 U/min
Nominal voltage	24 V	24 V
Mains frequency	0 Hz	0 Hz
Power consumption	150 W	150 W
Nominal current	6,3 A	6,3 A
IP degree of protection	44	44
Operating mode	S2 8 min	S2 8 min
Cable length	3 m	3 m
Unwinding speed max.	28 U/min	16 U/min
Unwinding speed tolerance max.	+4	+4
Dimension L1	582,0 mm	582,0 mm
Dimension L2	612,0 mm	612,0 mm
Dimension L3	632,0 mm	632,0 mm
Dimension L4	20,0 mm	20,0 mm
Dimension L5	30,0 mm	30,0 mm
Dimension Ø c	58 mm	58 mm

# Drive without limit switching

suitable for use for:

- Smoke curtain
- Smoke protection barrier
- Fire protection barrier

Item number

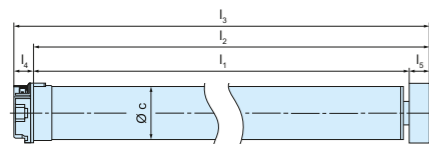

Designation

2030 096 004 0

XL30/14G 5A OE

2060 096 011 0

XL60/8G 5A OE

Smallest shaft inner tube diameter	60 mm	60 mm
Drive torque	30 Nm	60 Nm
Speed (load)	14 U/min	8 U/min
Speed (idling)	24 U/min	12 U/min
Nominal voltage	24 V	24 V
Mains frequency	0 Hz	0 Hz
Power consumption	150 W	150 W
Nominal current	6,3 A	6,3 A
IP degree of protection	44	44
Operating mode	S2 8 min	S2 8 min
Cable length	3 m	3 m
Unwinding speed max..	28 U/min	16 U/min
Unwinding speed tolerance max.	+4	+4
Dimension L1	582,0 mm	582,0 mm
Dimension L2	612,0 mm	612,0 mm
Dimension L3	632,0 mm	632,0 mm
Dimension L4	20,0 mm	20,0 mm
Dimension L5	30,0 mm	30,0 mm
Dimension Ø c	58 mm	58 mm



## Wiring

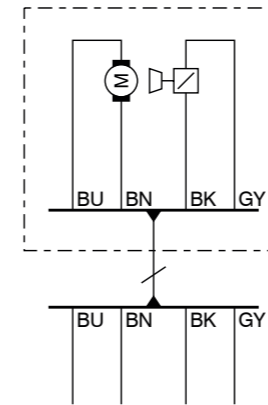

## Advantages

### Application



Made in Germany - for maximum reliability and durability



Fail-safe technology - drive enables usage in a de-energised state



Integrated closing speed regulator - limits the speed when rolling down in a de-energised state



Lifetime-lubricated special gear with special lubricant for low roll-up torque

### Planning



No integrated limit switching - switch-off at the limit positions is performed via an external control sensor



Increased axial load - the drive can be statically loaded with up to 150 kg



5-wire connecting cable



Integrated locking device - the approved 24V DC magnetic brake holds the drive in position in a powered state

### Installation



Limit position detection - detection of stop limit positions only possible via current detection of an external control unit

# Drive without limit switching

suitable for use for:

- Smoke curtain
- Smoke protection barrier
- Fire protection barrier

Item number

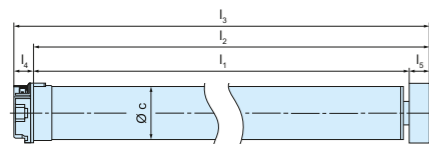

Designation

2030 096 008 0

XL30/14G 5A OE MH

2060 096 023 0

XL60/8G 5A OE MH

	XL30/14G 5A OE MH	XL60/8G 5A OE MH
Smallest shaft inner tube diameter	60 mm	60 mm
Drive torque	30 Nm	60 Nm
Speed (load)	14 U/min	8 U/min
Speed (idling)	24 U/min	12 U/min
Nominal voltage	24 V	24 V
Mains frequency	0 Hz	0 Hz
Power consumption	150 W	150 W
Nominal current	6,3 A	6,3 A
IP degree of protection	44	44
Operating mode	S2 8 min	S2 8 min
Cable length	3 m	3 m
Unwinding speed max.	28 U/min	16 U/min
Unwinding speed tolerance max.	+4	+4
Dimension L1	582,0 mm	582,0 mm
Dimension L2	612,0 mm	612,0 mm
Dimension L3	629,0 mm	629,0 mm
Dimension L4	17,0 mm	17,0 mm
Dimension L5	30,0 mm	30,0 mm
Dimension Ø c	58 mm	58 mm



## Wiring

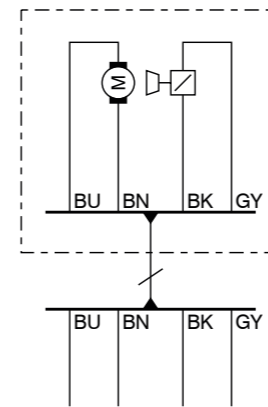

## Advantages

### Application



Made in Germany - for maximum reliability and durability



Fail-safe technology - drive enables usage in a de-energised state



Integrated closing speed regulator - limits the speed when rolling down in a de-energised state



Lifetime-lubricated special gear with special lubricant for low roll-up torque

### Planning



No integrated limit switching - switch-off at the limit positions is performed via an external control sensor



Increased axial load - the drive can be statically loaded with up to 150 kg



5-wire connecting cable



Integrated locking device - the approved 24V DC magnetic brake holds the drive in position in a powered state



Metal motor head

### Installation



Limit position detection - detection of stop limit positions only possible via current detection of an external control unit



## Control units

### Type matrix

	GSA 24V ASB
Voltage supply	24 V DC
Connection working current brake	yes
Connection release button	yes
Operating buttons Up-Down	no
Class of protection	IP65

## Chapter Content

Control units .....	44
Type matrix .....	44
Control unit GSA 24V ASB .....	46



## Control units

### Control unit GSA 24V ASB

Direct current control unit for the connection of 24V DC drives with stutter break.

- In plastic housing
- Outputs interlocked with each other
- Separate connection for working current brake
- Normally closed contact for connecting a release button
- Adjustable excess current shut-off



Item number	4007 000 019 0
IP degree of protection	65
Class of protection	I
Permissible ambient temperature min (control unit)	-25 °C
Permissible ambient temperature max (control unit)	40 °C

### Measurements and wiring

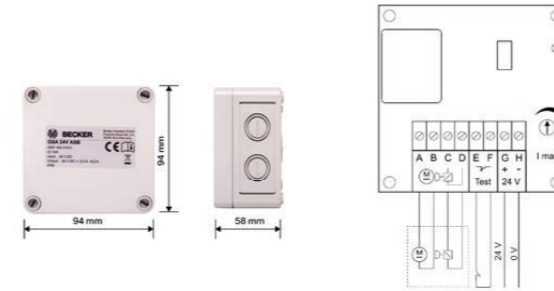

### Functional principle - sample wiring diagram

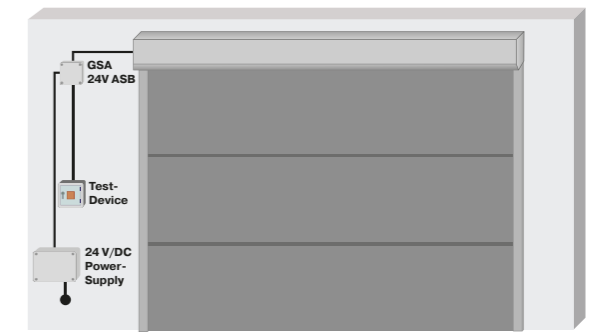



# Mechanical accessoires



# Chapter Content



**Mechanical accessoires ..... 48**

- Wall brackets ..... 50
- Wall brackets ..... 51
- Connecting pieces ..... 52
- Drive adapters and rings ..... 54
- Drive adapters and rings ..... 55
- Drive adapters and rings ..... 56



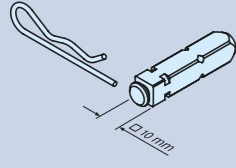
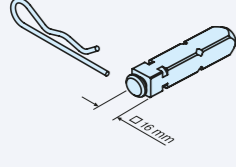
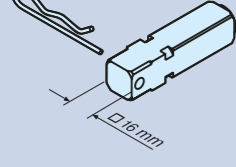
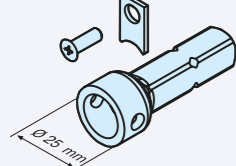
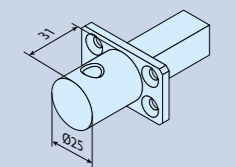
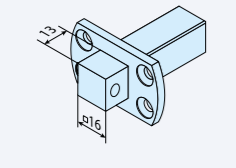
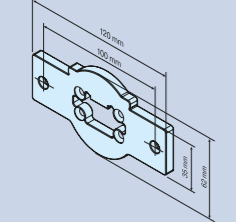

## Connecting pieces

connecting piece	Designation	Torque max.	Use for drive type	Item number
	Mounting pin-R 1/10 Square 10 mm	50 Nm	R = Ø 45mm	4930 200 026 0
	Mounting pin-L 1/16 Square, 16 mm	120 Nm	L = Ø 58mm	4931 200 040 0
	Mounting pin-L 2/16 Square, 16 mm	120 Nm	L = Ø 58mm	4931 200 034 0
	Mounting pin-L 3/25 round, d = 25 mm	200 Nm	L = Ø 58mm	4931 200 035 0
	Mounting pin 3/25, with con- nection strip 50 x 30 mm	120 Nm	L = Ø 58mm	4931 200 105 0
	Mounting pin with con- nection strip, square, 16x13 mm	120 Nm	L = Ø 58mm	4931 200 109 0
	B-strip-L	80 Nm	L = Ø 58mm	4931 300 169 0

## Drive adapters and rings

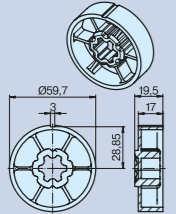
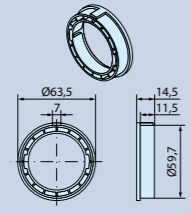
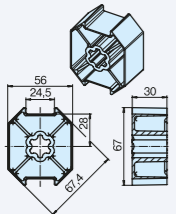
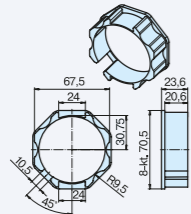
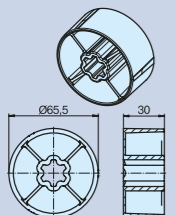
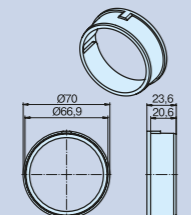
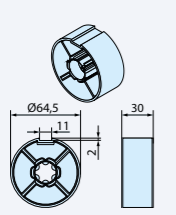
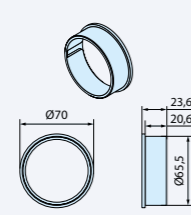
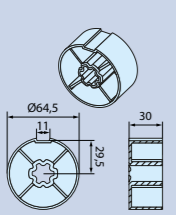
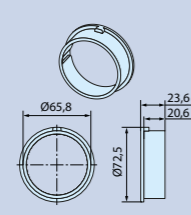
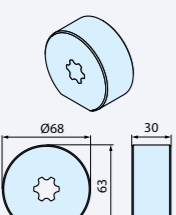
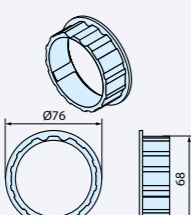
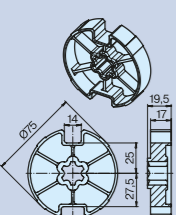
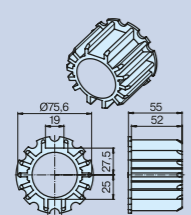
Drive adapter	Ring	Designation (Dimension)	Use for drive type	Torque max.	Item no.
		Drive Adapter 63 x 1,5 Plastic	R = Ø 45mm	30	4930 300 059 0
		Rings 63 x 1,5 Plastic	R = Ø 45mm		4930 300 060 0
		Drive adapter SM70 Zinc	L = Ø 58mm	120	4931 300 080 0
		Ring SM70 Plastic	L = Ø 58mm		4931 030 707 4
		Drive adapter 70 x 1,5 Zinc	L = Ø 58mm	120	4931 300 084 0
		Ring 70 x 1,5 Plastic	L = Ø 58mm		4931 050 707 4
		Drive adapter 70 x 2 Zinc	L = Ø 58mm	120	4931 300 385 0
		Ring 70x2 Plastic	L = Ø 58mm		4931 300 386 0
		Drive adapter 70 x 2 Zinc	L = Ø 58mm	120	4931 300 085 0
		Ring 70 x 2 Plastic	L = Ø 58mm		4931 060 707 4
		Drive adapter 76x4 Aluminium	L = Ø 58mm	120	4931 300 436 0
		Ring 76x4 Plastic	L = Ø 58mm		4931 300 437 0
		Drive adapter DW78 R+F Pressure die-casting Zinc	R = Ø 45mm	50	4930 300 091 0
		Ring DW78 R+F Plastic	R = Ø 45mm		4930 300 033 0

## Drive adapters and rings

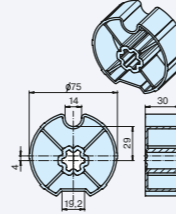
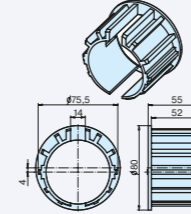
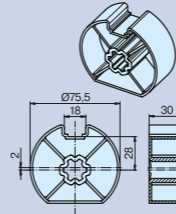
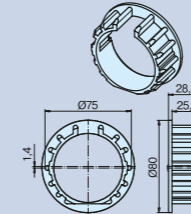
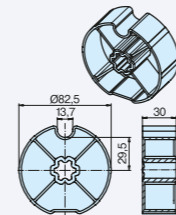
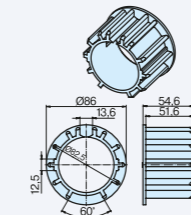
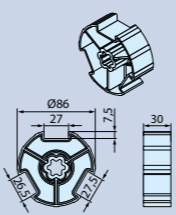
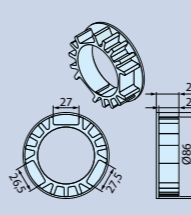
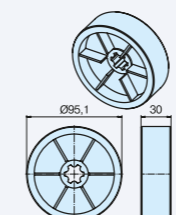
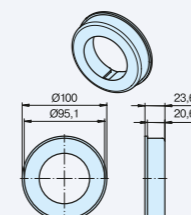
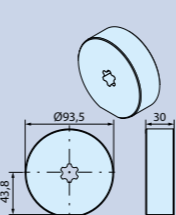
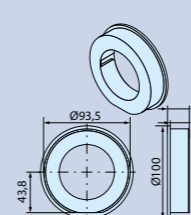
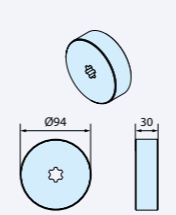
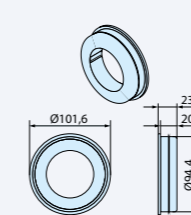
Drive adapter	Ring	Designation (Dimension)	Use for drive type	Torque max.	Item no.
		Drive adapter DW78N 4 mm center offset Zinc	L = Ø 58mm	120	4931 300 086 0
		Ring DW78N 4 mm center offset Plastic	L = Ø 58mm		4931 230 707 0
		Drive adapter DW78x1 Zinc	L = Ø 58mm	120	4931 300 079 0
		Ring DW78x1 Plastic	L = Ø 58mm		4931 210 707 1
		Drive adapter DW85N Zinc	L = Ø 58mm	120	4931 300 078 0
		Ring DW85N Plastic	L = Ø 58mm		4931 300 227 0
		Drive adapter 89 FU Zinc	L = Ø 58mm	120	4931 300 132 0
		Ring Deprat 89 Plastic	L = Ø 58mm		4931 300 133 0
		Drive adapter 100 x 2 Zinc	L = Ø 58mm	120	4930 300 185 0
		Ring 100 x 2 Plastic	L = Ø 58mm		4931 300 160 0
		Drive adapter 100 x 4 Aluminium	L = Ø 58mm	120	4930 300 443 0
		Ring 100 x 4 Plastic	L = Ø 58mm		4931 300 444 0
		Drive adapter 101,6 x 3,6 Aluminium	L = Ø 58mm	120	4931 300 175 0
		Ring 101,6 x 3,6 Plastic	L = Ø 58mm		4931 300 176 0

## Drive adapters and rings

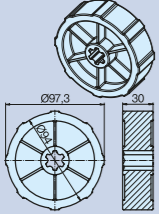
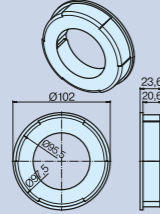
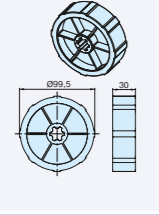
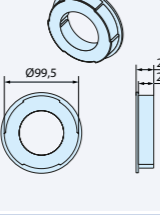
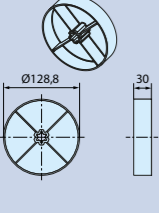
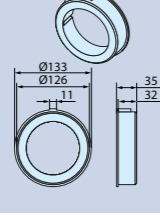
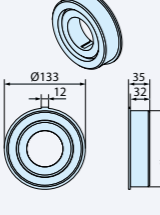
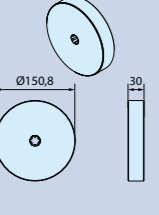
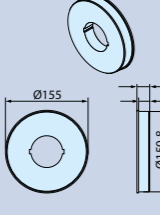
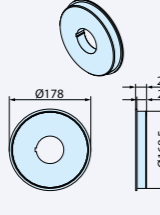
Drive adapter	Ring	Designation (Dimension)	Use for drive type	Torque max.	Item no.
		Drive adapter 102 x 2 Zinc	L = Ø 58mm	120	4931 300 104 0
		Ring 102 x 2 Plastic	L = Ø 58mm		4931 300 049 0
		Drive adapter 108 x 3,6 Zinc	L = Ø 58mm	120	4931 300 155 0
		Ring 108 x 3,6 Plastic	L = Ø 58mm		4931 300 043 0
		Drive adapter 133 x 2 Zinc	L = Ø 58mm	120	4931 300 120 0
		Ring 133 x 2 Plastic	L = Ø 58mm		4931 300 127 0
		Drive adapter 133 x 4 Aluminium	L = Ø 58mm	120	4931 300 177 0
		Ring 133 x 4 Plastic	L = Ø 58mm		4931 200 069 0
		Drive adapter 159 x 4 Aluminium	L = Ø 58mm	120	4931 300 172 0
		Ring 159 x 4 Aluminium	L = Ø 58mm		4931 300 173 0
		Drive adapter 177,8 x 4,5 Aluminium	L = Ø 58mm	120	4931 300 318 0
		Ring 177,8 x 4,5 Plastic	L = Ø 58mm		4931 300 319 0

# ANNEX

.....



# Chapter Content

.....

<b>ANNEX .....</b>	<b>58</b>
Extended Applications .....	60
General .....	
Conditions of sale .....	61
Becker Academy .....	62

# Extended Applications

Do you have requirements or preferences that extend beyond the scope of this catalogue?

We will gladly help with these and can design a customised solution for you. Whether you need different cable lengths, different drive torques or special functions. We will also gladly help you by providing CAD data during your design and development phase.

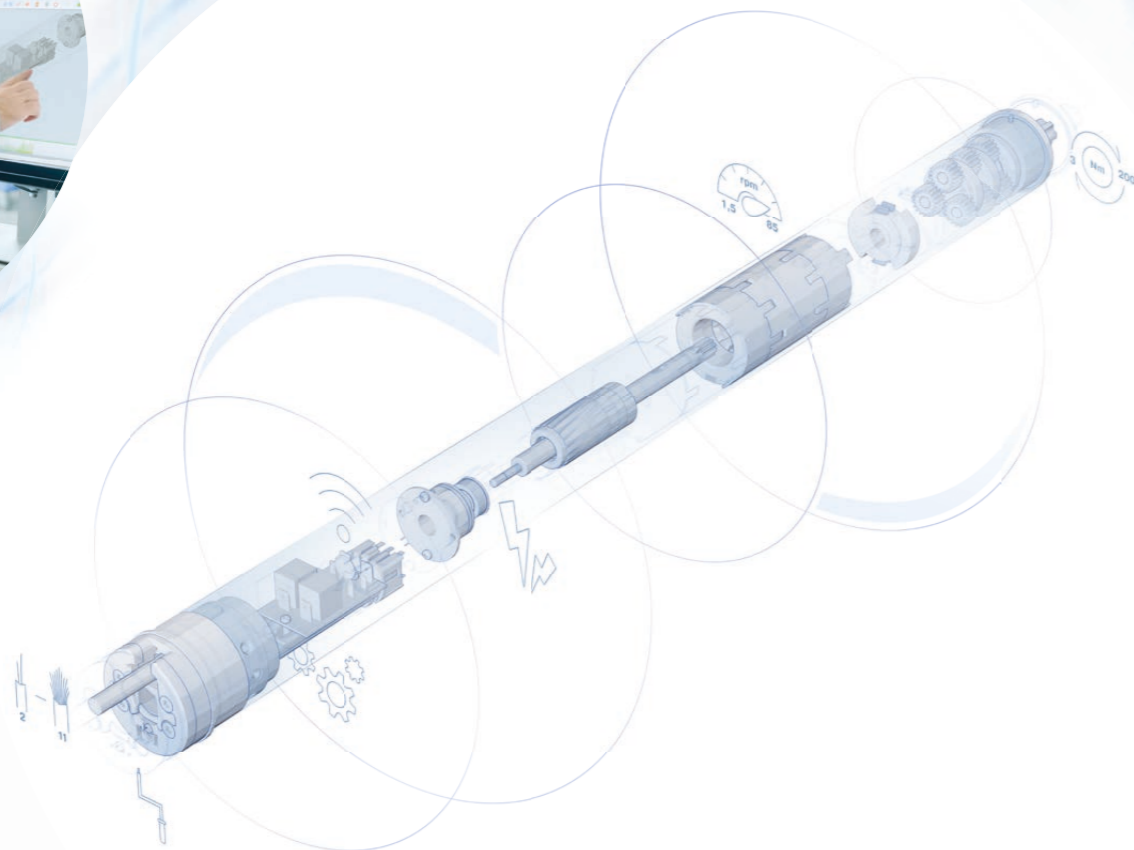

## Additional requirements? Just get in touch!

## General Conditions of sale

Please note our general conditions of sale.  
You can find these online at [www.becker-antriebe.com/agb](http://www.becker-antriebe.com/agb)



# Becker Academy

**We aim to get things moving.**  
**That's why we share our knowledge with our partners..**



## Knowledge makes the difference

As our partner, there's one thing you can always rely on: we're always at your side. At the same time, our Becker Academy will easily transform you into a qualified expert for all of our drive and control unit solutions – making you perfectly equipped for the challenges of today and tomorrow.

But above all we want our partners to get the best. This is why we regularly offer training courses and seminars at our Becker Academy to help you operate even more successfully in the market. Keep right up to date and benefit from an intensive exchange of knowledge





**BECKER-Antriebe GmbH**

Drives and control units for roller shutters,  
sun protection and additional applications

Friedrich-Ebert-Straße 2 – 4  
35764 Sinn, Germany

Tel.: +49(0)27 72 / 507-0  
Fax: +49(0)27 72 / 507-110

[info@becker-antriebe.com](mailto:info@becker-antriebe.com)  
[www.becker-antriebe.com](http://www.becker-antriebe.com)

Item number 4995 800 290 1, Version 07/2022

Copyrights for images: © Stöbich Brandschutz GmbH (P. 7 bottom), © KGG Brandschutzsysteme GmbH (P. 8, 19, 21),  
© CM Projekt GmbH (P. 15, 61, 62 bottom)

